

# User Manual

## RKR-768



Compatible with Windows 2000 / Windows XP / Windows Vista / Windows 7 .

## **Introduction**

RKR-768 is the wonderful combo set combining 2.4Ghz RF Keyboard and MCE Remote Control together. Both Keyboard and Remote are built in Optical Trackball for convenient use.

RK-768 radio wireless keyboard is one of the best computer input devices in the market today. It combines the convenience of radio frequency wireless and the trackball with two button mouse key and scroll wheel. It combined with RM-518 MCE RF remote control as a combo set, there are no cables connected to the keyboard & control, based on 2.4GHz radio frequency, 10-30 meters effective working range and 360 degree navigation.

Therefore, you can turn off the TV program that is broadcasting in the living room from the kitchen; you can sit in the balcony but choose the music that is broadcasting in the room; Switch the program or surf the Internet and E-mail, all of them, just use a small wireless remote control. Integrated with the wireless keyboard, carry on the on-line game or work happily will be more convenience.

Please read carefully the information and instructions contained in this manual and you are sure to obtain a higher level of computing enjoyment.

# Specification

- Microsoft Windows 2000 / Windows XP / Windows Vista / Windows 7 Compatible
- Keyboard: (RK-768)
  - 2.4GHz wireless with 16 channels. 360-degree navigation.
  - Working range: 10 meters.
  - 2-AA batteries, approx. 3 months battery life. (alkali batteries use only)
  - Energy saving management.
  - 10 Million Key switch life.
  - 103 keys, including 21 hot-keys & 2 mouse keys.
  - Built-in Optical trackball + 2 Mouse Buttons & Scroll Wheel.
  - Trackball: 19mm Optical, 800DPI.
  - Dimension: 425 x 150 x 31.5 mm.
- Remote: (RM-518)
  - 2.4GHz wireless with 8 channels, 360-degree navigation
  - Working range: 10 meters.
  - Built-in optical trackball, mouse key
  - Trackball: 19mm Optical, 800DPI
  - KEY: Including 45 hot-keys & 2 mouse keys & MCE keys.
  - Dimension: 178 x 50 x 33 mm
  - 2-AA batteries, approx. 3 months battery life (alkali batteries use only)
- Receiver:
  - USB interface
  - Dimension: 78 x 21.5 x 10 mm
- Patent No: ZL 2007 2 0143404.1 M318157  
ZL 2006 2 0002046.8 M296544  
Nr.20 2006 002 499.9

## Installation

1. Turn on the Computer.

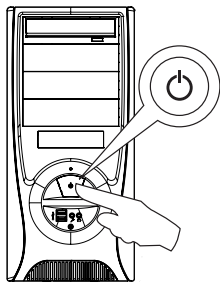

2. Plug the USB Receiver of the keyboard into the USB ports of your computer.

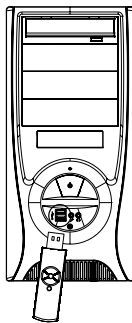

3. Open the battery cover on back of keyboard and Remote control, place AA batteries inside the battery compartment. Close the battery compartment cover.

Push to open

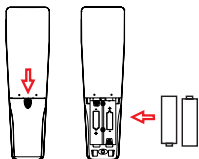

Push to open

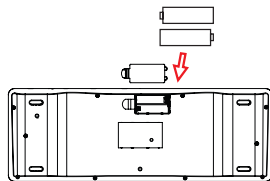
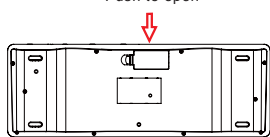

#### 4. Setting ID

##### Keyboard Setting:

- a. Press ID button on the receiver, the LED is on flash which means ID is searching. (Picture A)

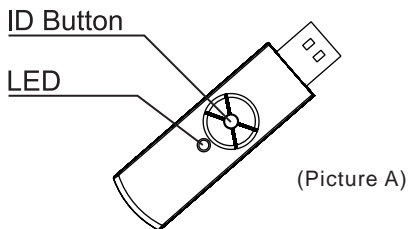

- b. Press ID button on Back of the keyboard, the LED is off which means setting is successful. (Picture B)

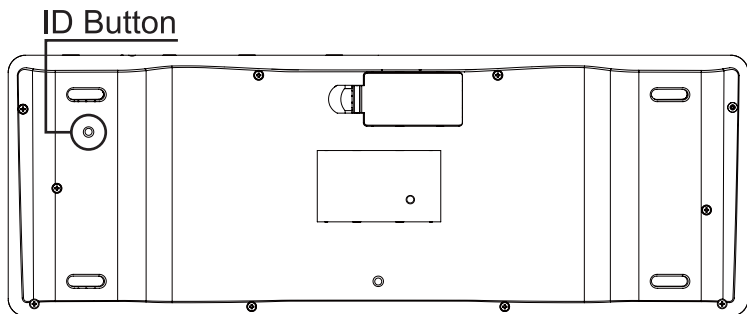

(Picture B)

## Remote Setting:

- Open the battery cover.
- Press ID button on the receiver, the LED is on flash which means ID is searching. (Picture A)
- Press ID button on the back of remote, the LED on the receiver is off which means setting is successful. (Picture B)

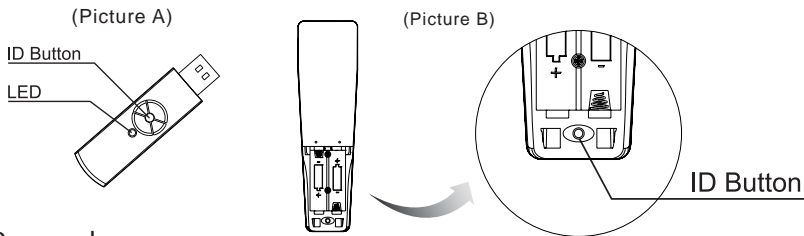

## Remarks

- RF Signal LED on the receiver will flash when the keyboard or remote is being used. (Picture A)
- When Battery Low LED lights, it means the keyboard or Remote requires changing batteries. (Picture B C)

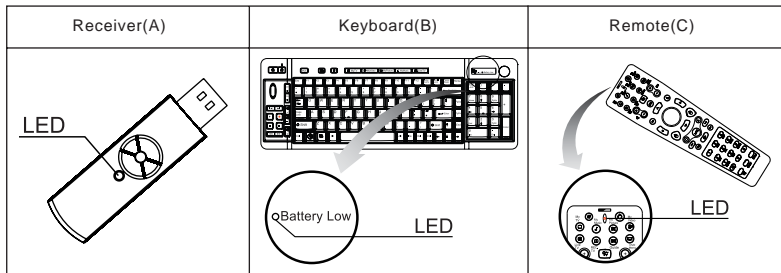

# Key Description

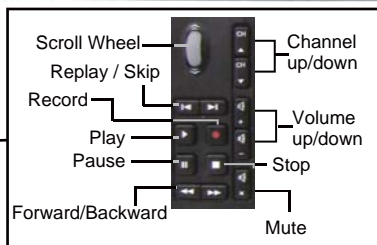
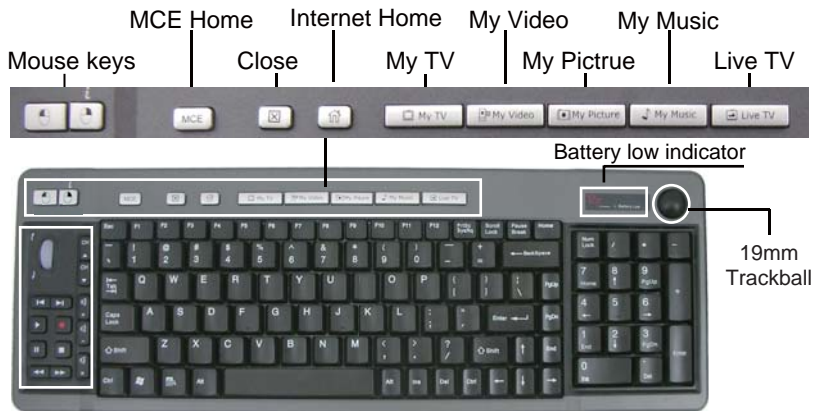

## Table of Functional Keys:

- Fn + Prtsc SysRq = PrtscSysRq
- Fn + Scroll Lock = Scroll Lock
- Fn + Pause Break = Pause Break
- Fn + Num Lock = Num Lock

## Notice:

The hot keys of **My TV**, **My Video**, **My Picture**, **Live TV**, and media hotkeys only can be used after the program of Media Center is activated; it can be simply done by the hotkey of **MCE**

## Remote Control Description

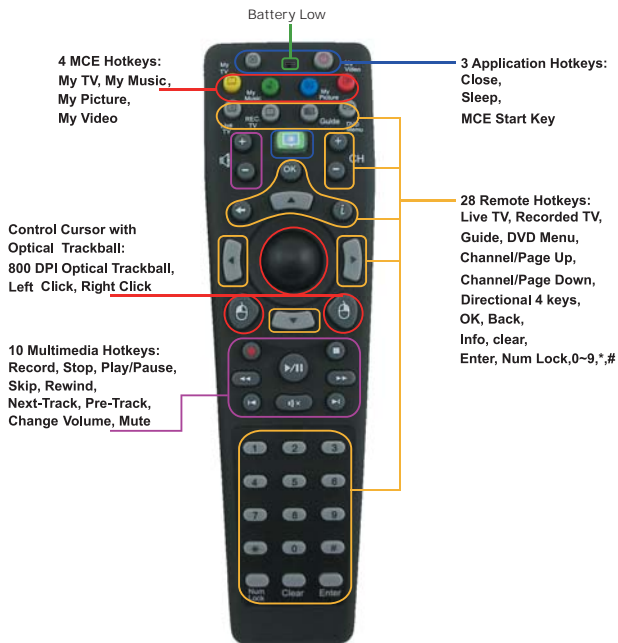

**Important:** In order to use My TV, My Video, My Picture, Live TV & Media hotkeys, Users need to activate the Media Center function first. To activate Media Center function, simply press the MCE hotkey.



## Trouble Shooting:

If your keyboard or remote control can not work after installation, please check followings:

- a. Make sure you have connected the receiver correctly to the computer; the receiver has been properly plugged onto computer's USB port.
- b. Make sure you have inserted AA batteries each into keyboard and remote, and they are compartment correctly. (2 pcs for keyboard,2 pcs for remote)
- c. If without any interference, such as other computer peripherals, the working distance (the distance between keyboard and the receiver) is about 10 meters.
- d. If using more than two units and interfere occurred, please reset ID again.

## Notice:

The changes or modifications not expressly approved by the party responsible for compliance could void the user's authority to operate the equipment.

## Important note:

To comply with the FCC RF exposure compliance requirements, no change to the antenna or the device is permitted. Any change to the antenna or the device could result in the device exceeding the RF exposure requirements and void user's authority to operate the device.

## **FCC information:**

The Federal Communication Commission Radio Frequency Interference Statement includes the following paragraph:

The equipment has been tested and found to comply with the limits for a Class B Digital Device, pursuant to part 15 of the FCC Rules. These limits are designed to provide reasonable protection against harmful interference in a residential installation.

This equipment generates uses and can radio frequency energy and, if not installed and used in accordance with the instruction, may cause harmful interference to radio communication.

However, there is no grantee that interference will not occur in a particular installation. If this equipment dose cause harmful interference to radio or television reception, which can determined by turning the equipment off and on, the user is encouraged to try to correct the interference by one or more of the following measures:

- Reorient or relocate the receiving antenna.
- Increase the separation between the equipment and receiver.
- Connect the equipment into an outlet on a circuit different from that to which the receiver is connected. Consult the dealer or an experienced radio/TV technician for help.